

# Excel Environ WR600 Wall Rack Network Data Cabinet 6U WxD 600mm x 600mm Black

Item Code: WB6.6SGB

**excel**  
without compromise.



- ✕ Choice of depths available (390mm, 500mm, 600mm)
- ✕ Available in Black or Grey
- ✕ Aesthetically pleasing framed safety glass front door
- ✕ Quick release doors and side panel
- ✕ Adjustable front and rear 19" mounting profiles
- ✕ Removable cable entry panel in top and base

## Product Overview

WB6.6SGB Excel Environ WR600 Wall Rack Network Data Cabinet 6U WxD 600mm x 600mm Black, part of a huge range of Network Data Cabinets available from Mayflex. The Excel Environ WR is a range of wall-mounted 600mm wide racks designed for the installation of both cabling and equipment.

The WR series of Wall Racks is available in depths of 390mm, 500mm and 600mm and is suitable for multiple applications including local area networking (LAN) cabling and hardware, and the housing of security, audio and visual equipment.

## Product Specifications

Feature	Values
Mounting Profile	Front and rear
Model	With permanent frame
Type of profile rail	L-shaped
Number of doors	1
Type of ventilation	Passive
Width	600 mm
Height	368 mm
Depth	600 mm

# Excel Environ WR600 Wall Rack Network Data Cabinet 6U WxD 600mm x 600mm Black

Item Code: WB6.6SGB



Modular spacing	19 inch
Number of rack units (RU)	6
Max. load capacity	60 kg
With roof plate	Yes
With front door	Yes
Side panels included	Yes
Material	Steel
Type of surface	Powder coated
Colour	Black
RAL-number	9004
IP-rating	IP20

## Additional specifications

Features	Values
Frame	1.20mm
Top cover and fan entry plate	1.20mm
19" mounting angles	1.50mm
Side panels	1.20mm
Front door frame	1.20mm
Front door glass	5.00mm
Cable Entry Knock Out (Roof & Base)	230 mm x 45 mm

## Standards

Standard	Detail
BS EN 60297-3-100:2009	Mechanical structures for electronic equipment. Dimensions of mechanical structures of the 482,6 mm (19 in) series. Basic dimensions of front panels, subracks, chassis, racks and cabinets
BS 3193:2008	Specification for thermally toughened glass panels for use in domestic appliances
WFD	Compliant to Waste Framework Directive
SCIP	Compliant - Does Not Contain Substances of Concern in Products

# Excel Environ WR600 Wall Rack Network Data Cabinet 6U WxD 600mm x 600mm Black

Item Code: WB6.6SGB



## Product images



- Aesthetically pleasing design with framed glass front door



- Lockable, quick release side panels, for maximum access into cabinet



- Cable entry cut out in top and base

- Angled vented roof

- Adjustable 19" mounting profiles

# Excel Environ WR600 Wall Rack Network Data Cabinet 6U WxD 600mm x 600mm Black

Item Code: WB6.6SGB



## Exploded view

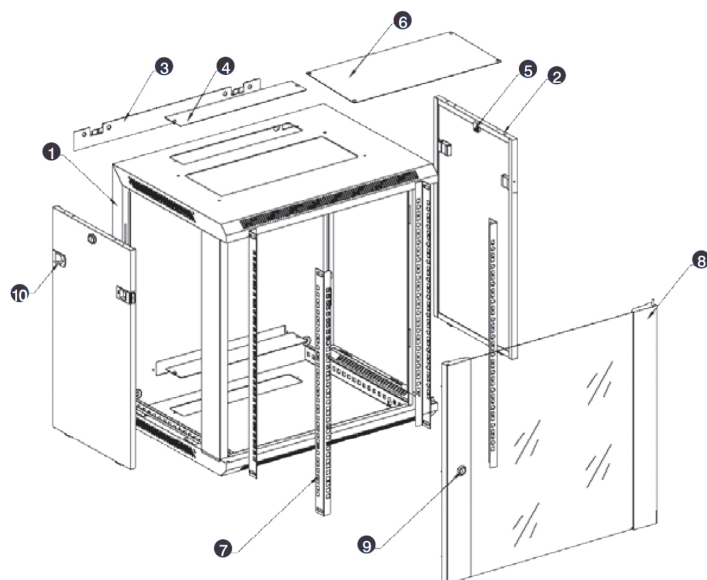

- ① Frame
- ② Side panel
- ③ Mounting panel
- ④ Cable entry cover, removeable
- ⑤ Side key lock
- ⑥ Fan cover, removeable
- ⑦ Mounting profile
- ⑧ Front door
- ⑨ Front door key lock
- ⑩ Slam latch lock



- ① Slam latch lock
- ② Side panel
- ③ Mounting panel
- ④ Cable entry cover, removeable
- ⑤ Side key lock
- ⑥ Fan cover, removeable
- ⑦ Mounting profile
- ⑧ Front door
- ⑨ Front door key lock

# Excel Environ WR600 Wall Rack Network Data Cabinet 6U WxD 600mm x 600mm Black

Item Code: WB6.6SGB



## Product drawings

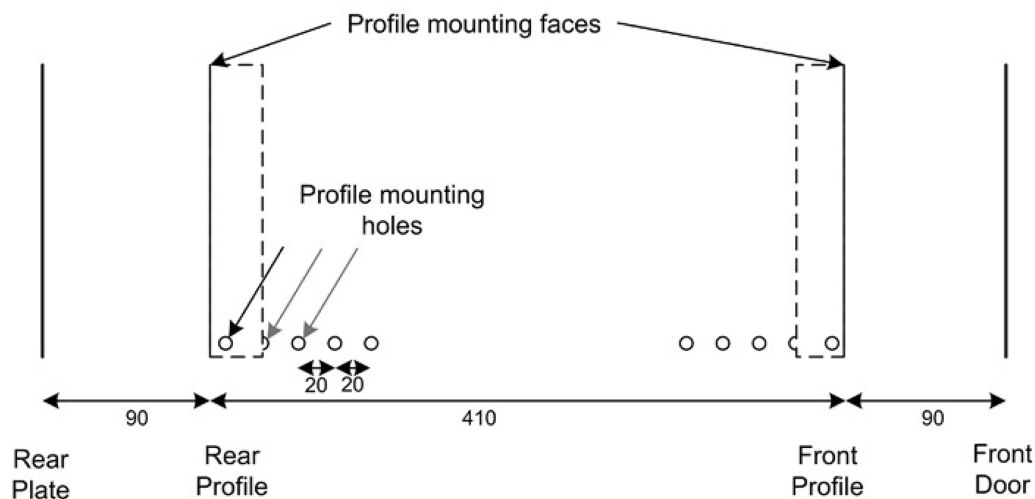

All dimensions in mm

## Part Number Table

Part Number	Description
WB12.6SG	Excel Environ WR600 Wall Rack Network Data Cabinet 12U WxD 600mm x 600mm Grey
WB12.6SGB	Excel Environ WR600 Wall Rack Network Data Cabinet 12U WxD 600mm x 600mm Black
WB15.6SG	Excel Environ WR600 Wall Rack Network Data Cabinet 15U WxD 600mm x 600mm Grey
WB15.6SGB	Excel Environ WR600 Wall Rack Network Data Cabinet 15U WxD 600mm x 600mm Black
WB18.6SG	Excel Environ WR600 Wall Rack Network Data Cabinet 18U WxD 600mm x 600mm Grey
WB18.6SGB	Excel Environ WR600 Wall Rack Network Data Cabinet 18U WxD 600mm x 600mm Black
WB21.6SG	Excel Environ WR600 Wall Rack Network Data Cabinet 21U WxD 600mm x 600mm Grey
WB21.6SGB	Excel Environ WR600 Wall Rack Network Data Cabinet 21U WxD 600mm x 600mm Black
WB6.6SG	Excel Environ WR600 Wall Rack Network Data Cabinet 6U WxD 600mm x 600mm Grey

# Excel Environ WR600 Wall Rack Network Data Cabinet 6U WxD 600mm x 600mm Black

Item Code: WB6.6SGB



WB6.6SGB	Excel Environ WR600 Wall Rack Network Data Cabinet 6U WxD 600mm x 600mm Black
WB9.6SG	Excel Environ WR600 Wall Rack Network Data Cabinet 9U WxD 600mm x 600mm Grey
WB9.6SGB	Excel Environ WR600 Wall Rack Network Data Cabinet 9U WxD 600mm x 600mm Black
WBFP12.6SG	Excel Environ WR600 Flat Packed Wall Rack Network Cabinet 12U WxD 600mm x 600mm Grey
WBFP12.6SGB	Excel Environ WR600 Flat Packed Wall Rack Network Cabinet 12U WxD 600mm x 600mm Black
WBFP15.6SG	Excel Environ WR600 Flat Packed Wall Rack Network Cabinet 15U WxD 600mm x 600mm Grey
WBFP15.6SGB	Excel Environ WR600 Flat Packed Wall Rack Network Cabinet 15U WxD 600mm x 600mm Black
WBFP18.6SG	Excel Environ WR600 Flat Packed Wall Rack Network Cabinet 18U WxD 600mm x 600mm Grey
WBFP18.6SGB	Excel Environ WR600 Flat Packed Wall Rack Network Cabinet 18U WxD 600mm x 600mm Black
WBFP21.6SG	Excel Environ WR600 Flat Packed Wall Rack Network Cabinet 21U WxD 600mm x 600mm Grey
WBFP21.6SGB	Excel Environ WR600 Flat Packed Wall Rack Network Cabinet 21U WxD 600mm x 600mm Black
WBFP6.6SG	Excel Environ WR600 Flat Packed Wall Rack Network Cabinet 6U WxD 600mm x 600mm Grey
WBFP6.6SGB	Excel Environ WR600 Flat Packed Wall Rack Network Cabinet 6U WxD 600mm x 600mm Black
WBFP9.6SG	Excel Environ WR600 Flat Packed Wall Rack Network Cabinet 9U WxD 600mm x 600mm Grey
WBFP9.6SGB	Excel Environ WR600 Flat Packed Wall Rack Network Cabinet 9U WxD 600mm x 600mm Black

Excel is a world class premium performing end to end infrastructure solution designed, Manufactured, supported and delivered without compromise.

Contact us at [sales@excel-networking.com](mailto:sales@excel-networking.com)



E&OE. Excel is a registered trade name of Mayflex Holdings Ltd.